

FAQs

What is included in the TempWall system?

The system has:

- One fully assembled wall made with three interlocking panels, secured at the top by a 60" U-channel trim.
- Two Gator Foot Plates
- Two U-style top/bottom clips
- Two T-style top/bottom clips
- 20 x Stainless steel screws

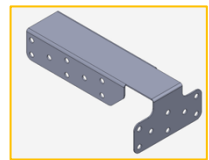
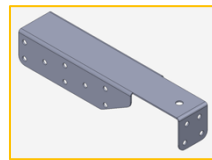
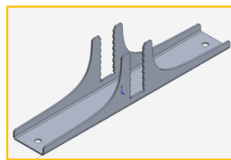

What are the dimensions of the panel?

The pre-assembled wall section is 60" wide x 80" high x 1-3/8" thick (152.4 cm x 203.2 cm x 3.49 cm) and weighs 58 lbs (22.68 kg).

Do I need any additional tools for assembly?

Yes, you will need a cordless drill with a #2 Robertson or #2 Phillips bit. You may require a rubber mallet to remove the Gator foot plates.

How can I configure the panels?

The panels have many configuration options, and it will depend on the space they are being installed in and the use case. Some of the more common configurations include:

- Stand-alone
- L-shape
- U-shape
- Double-U
- Multi-U
- Zigzag

Diagrams of possible combinations are below.

TempWall

by **trusscore**

Quick and easy to
install temporary
modular wall system

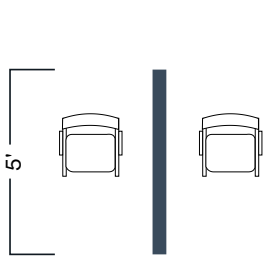

Single

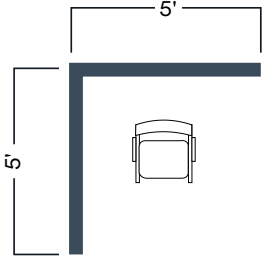

L-shape

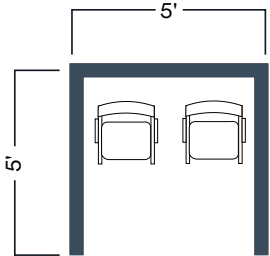

U-shape

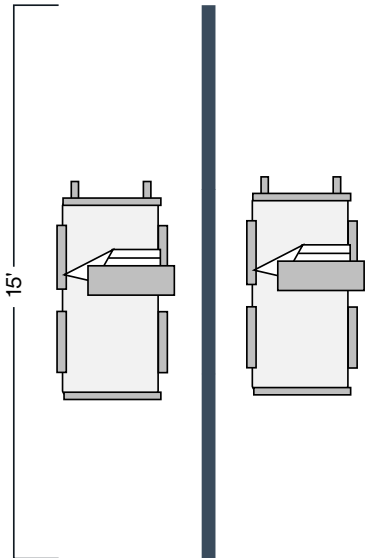

Inline

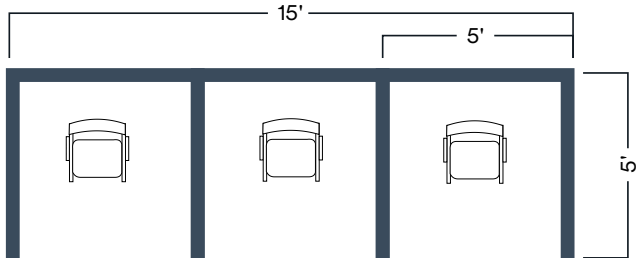

Multi-U

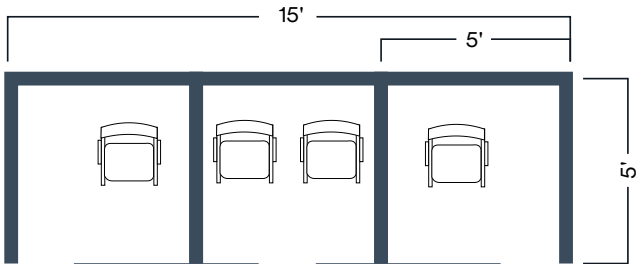

Multi-U Privacy

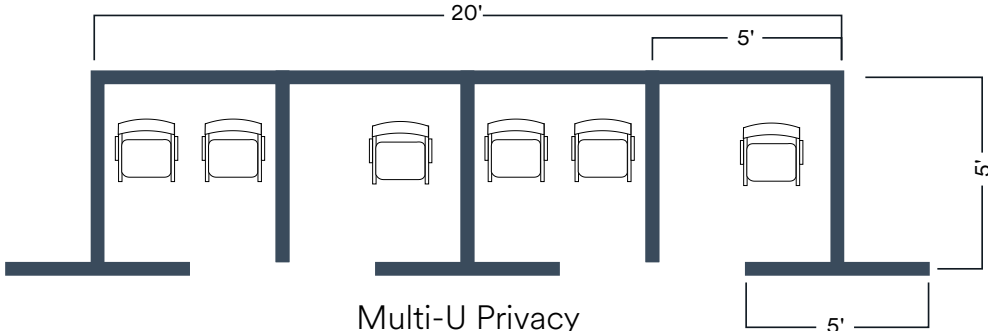

Multi-U Privacy

TempWall

by **trusscore**

Quick and easy to
install temporary
modular wall system

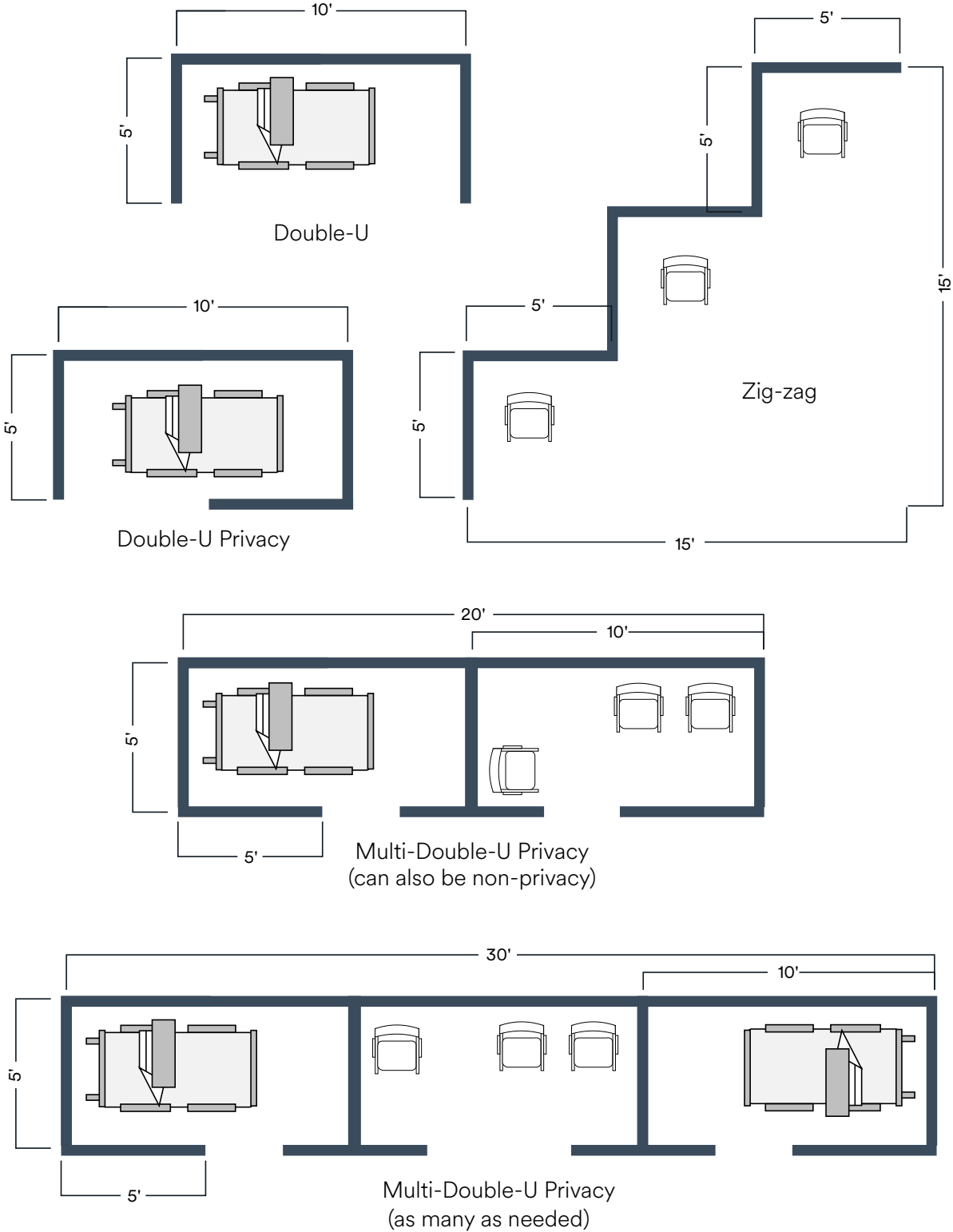

How long does it take to assemble the system?

It will take less than 5 minutes to assemble a stand-alone configuration, and approximately 10-15 minutes for a U-shape configuration.

What is the lead time?

The lead time is 2-3 days to ship. Production capacity is approximately 400 TempWall systems per day.

What are the shipping options?

TempWall systems can be most rapidly and optimally shipped 28 per pallet (60" x 82" x 48"). 20 pallets can be transported in a truckload for a quantity of 560 in 53' trailer.

What is Microban Aegis Microbe Shield?

Microban AEGIS® Microbe Shield helps to protect surfaces from harmful microbes. The technology polymerizes (bonds) to surfaces resulting in a strong, durable, invisible, and effective barrier with a long history of safe use. AEGIS is proven to control and prevent the growth of an extremely wide range of microorganisms such as bacteria, algae, yeasts, mold, and mildew.

It's ideal for institutional, healthcare, public shared facilities, and outdoor environments our technologies can provide an extra level of hygiene protection with a 99.9% microbial reduction rate.

More information can be found here: <https://www.microban.com/antimicrobial-solutions/technologies/aegis-microbe-shield>